

Delta-3 Series

DRQP

DIGITAL GATE RECEIVER

Installation Instructions

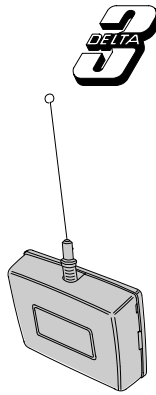

Linear®

(800) 421-1587 • www.linearcorp.com

DESCRIPTION

The DRQP is a high-sensitivity, short-range radio receiver that operates in conjunction with the 9-inch local antenna (supplied) or the EXA-GP remote antenna (not included). The DRQP is designed for use with automatic gate operators or systems where a remote antenna is needed.

All of the Delta-3 transmitters, including the two and four-channel transmitters, are compatible with the the DRQP. The Delta-3 radio format provides 256 different digital codes. The codes are set using the 8-position coding switches in the units. In order to avoid the possibility of duplicating codes in adjacent systems, factory set codes should not be used. In addition, among the valid codes available, four others should not be used. These include: all keys set ON or OFF and keys set alternating ON/OFF. Receivers are normally powered with 24 volts AC/DC from the gate operator.

The DRQP has a built-in "F" connector and is supplied with a 9-inch local antenna. The EXA-GP Remote Antenna may be used to enhance the operational range of the DRQP.

STEP 1A Receiver code setting. Locate the receiver coding switch which is recessed in the back of the receiver case. To set a code, select any valid combination of ON and OFF positions for the switch keys numbered 1 through 8. Use a paper clip to set the eight keys on your receiver.

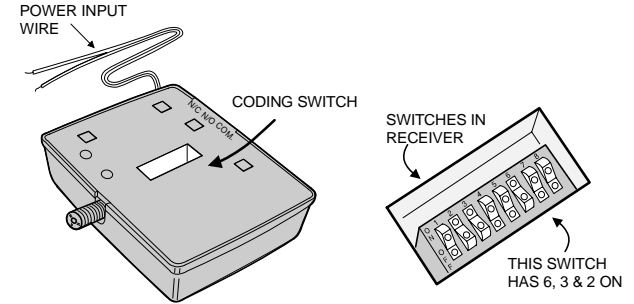

STEP 1B Transmitter code setting. Locate the coding switch on the transmitter and set the eight keys identical to those on the receiver. Be sure they are both coded from left to right! Be sure they are identical! If using a two or four-channel transmitter refer to the coding instructions included with the transmitter for proper system coding.

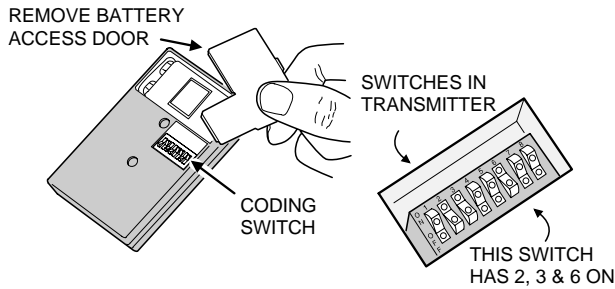

STEP 2 Connect receiver output. Connect the output terminals (1 & 2) to the appropriate activation terminals on the gate operator.

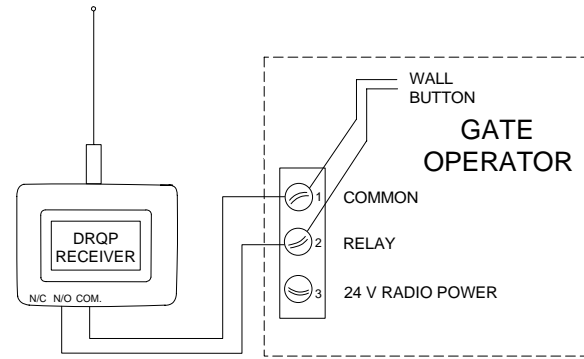

STEP 3 Connect receiver to 24V power. Connect the white power input wires to the 24V and Common terminals on the gate operator. If using DC power, gold wire (+), silver wire (-).

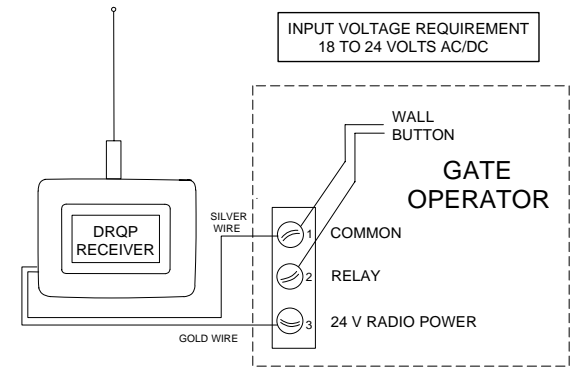

STEP 4 Optional Receiver mounting bracket. If the receiver isn't going to be mounted directly to the operator terminals, an optional mounting bracket is supplied. It can be installed two ways onto the DRQP case. Screw the bracket to a wall or stud and snap the receiver onto it. Attach the 9-inch antenna or the EXA-GP antenna coaxial cable to the "F" connector.

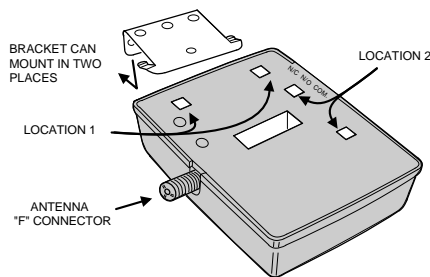

STEP 5 Test receiver. Be sure gate area is clear. Activate each transmitter and verify that the receiver triggers the operator.

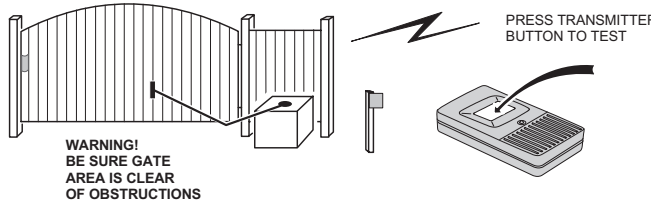

LIMITED WARRANTY

This product is warranted to the consumer against defects in material and workmanship for one year from the date of purchase. This warranty applies to first retail buyers of new devices. Warrantor will repair, or at its option, replace, any device it finds that requires service under this warranty, and will return the repaired or replaced device to the consumer at the warrantor's cost. For warranty service and shipping instructions contact warrantor at the address shown below. Devices must be sent to warrantor for service at owner's expense. The remedies provided by this warranty are exclusive. Implied warranties under state law are to the one year period of this written warranty. Some states do not allow limitations on how long an implied warranty lasts, so the above limitation may not apply to you. In order to be protected by this warranty, save your proof of purchase and send copy with equipment should repair be required. This warranty gives you specific legal rights, and you may also have other rights which vary from state to state.

All products returned for warranty service require a Return Product Authorization Number (RPA#). Contact Linear Technical Services at 1-800-421-1587 for an RPA# and other important details.

IMPORTANT !!!

Linear radio controls provide a reliable communications link and fill an important need in portable wireless signaling. However, there are some limitations which must be observed.

- * For U.S. installations only: The radios are required to comply with FCC Rules and Regulations as Part 15 devices. As such, they have limited transmitter power and therefore limited range.
- * A receiver cannot respond to more than one transmitted signal at a time and may be blocked by radio signals that occur on or near their operating frequencies, regardless of code settings.
- * Changes or modifications to the device may void FCC compliance.
- * Infrequently used radio links should be tested regularly to protect against undetected interference or fault.
- * A general knowledge of radio and its vagaries should be gained prior to acting as a wholesale distributor or dealer, and these facts should be communicated to the ultimate users.